

VS7036

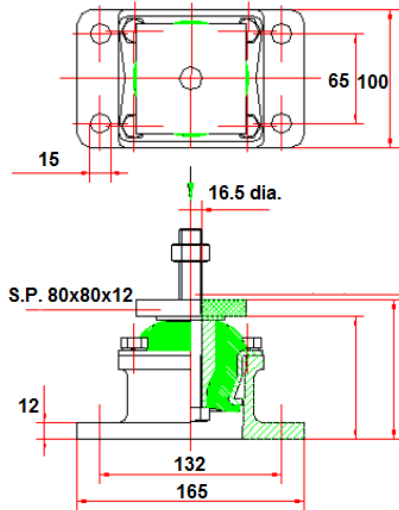

VS7044

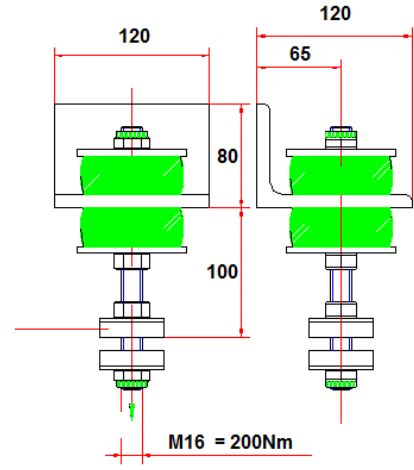

VS7037

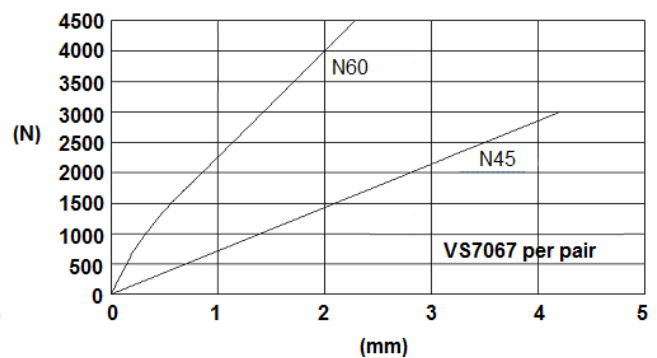
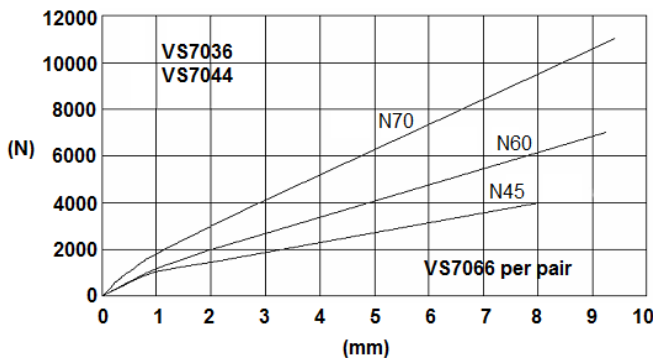

VS7066

VS7067

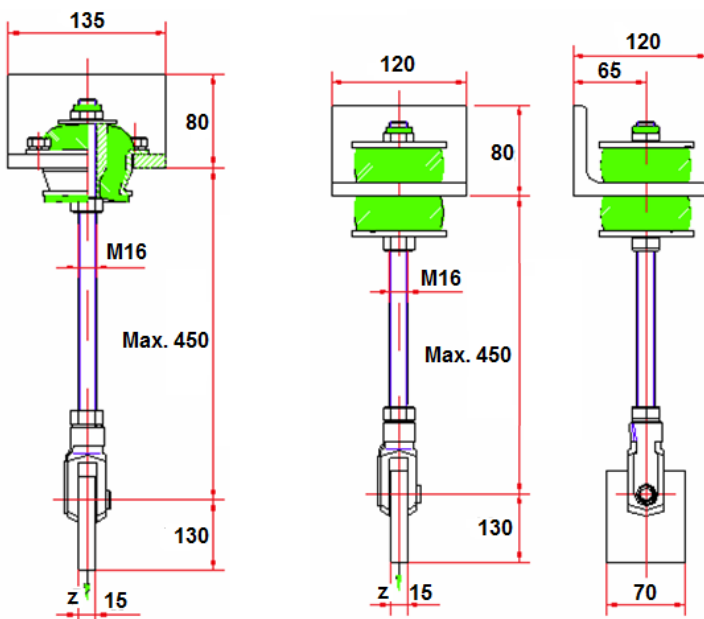

As VS7067 but with double height rubber elements and half the unit stiffness. Stabiliser loads are shown for pairs installed at 90 degrees. Stabiliser with stainless steel end plates are available for stainless steel pipe work systems. To order any support, the part number is obtained by using the VS number and the last three characters from the relevant load deflection chart.

E.g. For VS7067 in N60, the part number is VS7067 N60, or with stainless steel end plate VS7067 N60 SS.